

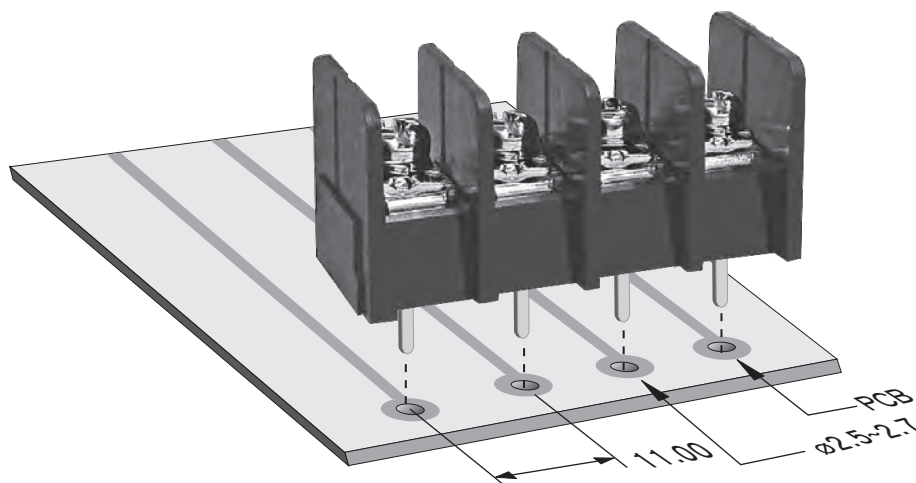



TYPE: TA6 (貫通式端子台)

Pitch:11.00mm

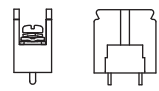
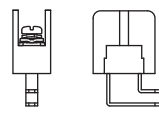

ORDER GUIDE(注文方法):

TA6-B M10 04

Body(本体)	Terminal style(端子スタイル)	Poles(極数)
<p>B: 取付穴・カバー無し、壁有り (Barrier Ends)</p> 	<p>D10</p>  <p>X02</p> 	<p>02</p> <p>⋮</p> <p>10</p>
<p>K: 取付穴・壁有り、カバー付き (Mount Ends and Cover)</p> 		
<p>E: 取付穴無し、壁有り、カバー付き (Barrier Ends with Cover)</p> 		

SPECIFICATION(規格,仕様):

Terminal :	Brass, Tin plated, 1.0 t	端子金具 :	黄銅板 ハンダメッキ, 1.0 t
Insulator body :	PBT(UL94V-0), Black	本体 :	PBT(UL94V-0), 黒色
Screw :	M4.0, steel, Ni plated	端子ネジ :	M4.0, 鉄ニッケルメッキ
Cover :	PC	カバー :	PC
Operation temperatures :	-40° C to +120° C	使用温度範囲 :	-40° C to +120° C
Rated current :	40Amp 600V	定格 :	40Amp 600V
Insulation withstands volt :	2000V 1min	耐電圧 :	2000V 一分間
Insulation resistance :	2000MΩ at DC 500V	絶縁抵抗 :	DC 500V 2000MΩ
PCB hole Dia :	φ 2.5mm~φ 2.7mm	基板穴径 :	φ 2.5mm~φ 2.7mm
Wire range :	10~18 AWG	適合電線 :	10~18 AWG
Screw torque :	14 lb-in	締付トルク :	14 lb-in
	Screw with washer		ワッシャー付ネジ

.433" PCB Barrier Terminal Blocks

TYPE: TA6

Pitch:11.00mm

TA6-BM10-04

Terminal style:M10

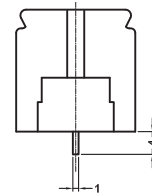
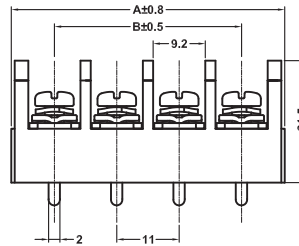
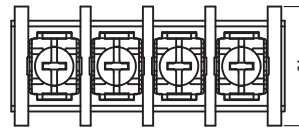
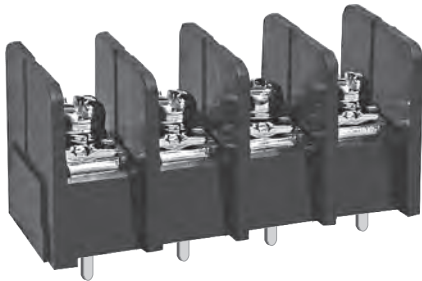

TA6-BD10-04

Terminal style:D10

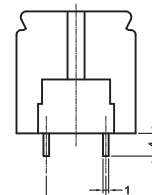
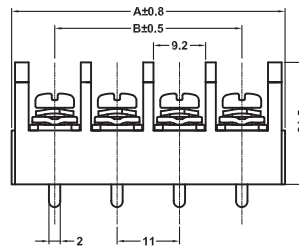
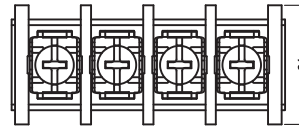
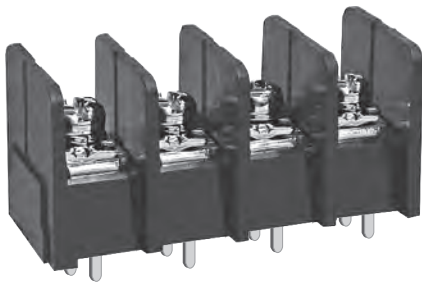

TA6-BX02-04

Terminal style:X02

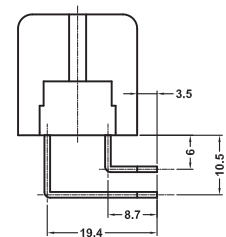
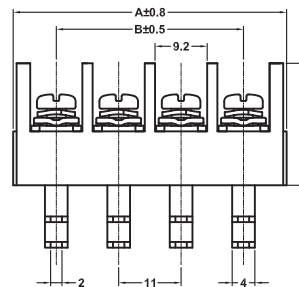
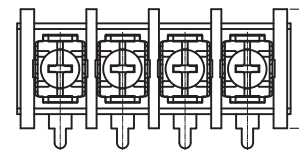
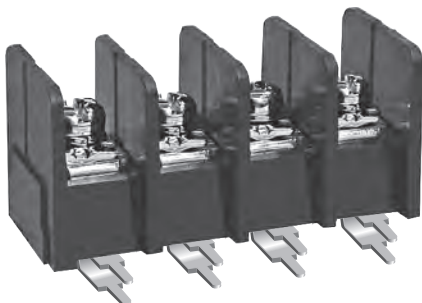

Poles	2	3	4	5	6	7	8	9	10	11
A(mm)	25.00	36.00	47.00	58.00	69.00	80.00	91.00	102.00	113.00	124.00
B(mm)	11.00	22.00	33.00	44.00	55.00	66.00	77.00	88.00	99.00	110.00