

ME550 Male Connector

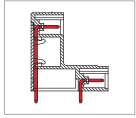

DIMENSIONS/POSITIONS

DIMENSIONS/POSITIONS		ME550-350	ME550-381
間距	Pitch	3.50mm	3.81mm
位數	Poles	4 ~ 40Poles	4 ~ 40Poles
塑膠本體	Housing Material	PA 66	PA 66
焊針	Pin Dimensions	Brass, Tin Plated	Brass, Tin Plated
PCB孔徑	PCB Hole Diameter	1.4mm	1.4mm
環境作業溫度	Operating Temperature	-40°C to +105°C	-40°C to +105°C

TECHNICAL DATA

連接符合標準 Connection in acc. with standard EN-VDE			
額定電流 I _n	Nominal Current I _n	7A	7A
額定橫截面	Nominal Cross Section	-	-
最大負載電流	Maximum load current	7A	7A
絕緣材料	Insulating Material	PA	PA
阻燃等級,符合UL94 Inflammability class acc. to UL94		V0	V0
額定電壓,UL/CUL Nominal voltage, UL/CUL		300V	300V
額定電流,UL/CUL Nominal current, UL/CUL		8A	10A

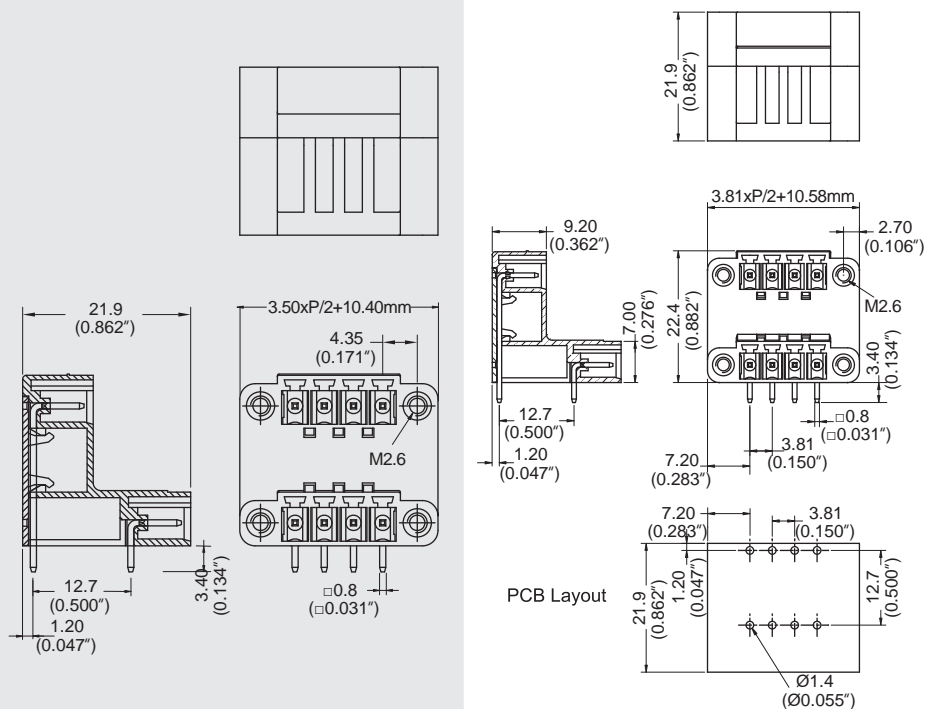

ME